

## FEATURES

- Fast time response
- High time resolution
- Compact profile

## APPLICATIONS

- LIDAR (Light Detection and Ranging)
- TCSPC (Time-Correlated Single Photon Counting)
- High energy physics

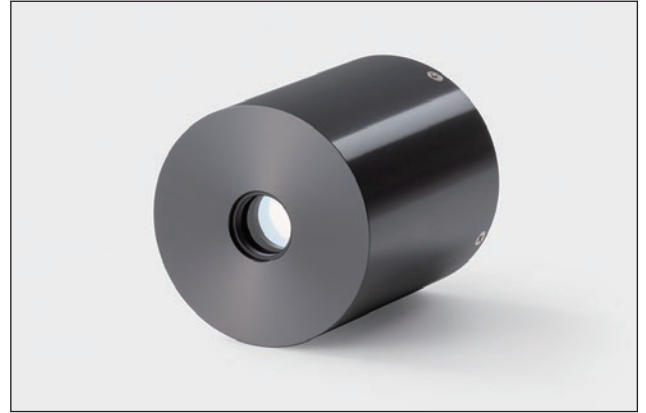

## SPECIFICATIONS

(at +25 °C)

Parameter			-50	-52	-61	-64	Unit
Spectral response			160 to 850	160 to 650	370 to 920	280 to 720	nm
Peak wavelength			430	420	750 to 850	550 to 650	nm
Photocathode material			Multialkali	Bialkali	GaAs	GaAsP	—
Window material			Synthetic silica		Borosilicate		—
Effective area			φ11		φ10		mm
Dynode structure			2-stage filmed MCP				—
MCP channel diameter			6				μm
Capacitance between anode and MCP out			3				pF
Maximum ratings	Supply voltage		-3400				V
	Operating ambient temperature <sup>①②</sup>		-50 to +50				°C
	Storage temperature <sup>②</sup>		-50 to +50				°C
Cathode	Luminous	Min.	100	20	400		μA/lm
		Typ.	180	50	700		
	Radiant sensitivity <sup>④</sup>	Typ.	70	50	85	180	mA/W
Gain <sup>③</sup>		Min.	1.0 × 10 <sup>5</sup>				—
		Typ.	3.0 × 10 <sup>5</sup>				
Anode <sup>③</sup>	Luminous	Typ.	54	15	210	210	A/lm
	Dark current <sup>⑤</sup>	Typ.	2.0	0.5	5.0	3.0	nA
	Dark count <sup>⑤</sup>	Typ.	700	50	100 <sup>⑥</sup>	10 000	
Max.		2000	200	500 <sup>⑥</sup>	30 000		
Time response <sup>③</sup>	Rise time	Typ.	160		200		ps
		Max.	200		280	250	
	Fall time	Typ.	360		500		
	Width	Typ.	350		480		
	I.R.F. (FWHM) <sup>⑦</sup>	Typ.	45		150	90	
		Typ.	25		145	85	
T.T.S. (FWHM) <sup>⑧</sup>	Max.	35		250	150		

**NOTES:** ①We recommend to use R3809U-61 with thermoelectric cooling unit to reduce dark counts. (Refer to Accessories)

②No condensation. ③Supply voltage is -3000 V ④Measured at the peak sensitivity wavelength.

⑤After 30 min storage in darkness

⑥At -30 °C

⑦I.R.F. stands for Instrument Response Function which is a convolution of the pulse function ( $H(t)$ ) of the measuring system and the excitation function ( $E(t)$ ) of a laser. The I.R.F. is given by the following formula:

$$I.R.F. = H(t) \times E(t)$$

We specify the I.R.F. as an FWHM of the time distribution taken by using the measuring system that is Hamamatsu standard I.R.F. measurement. It can be temporary estimated by the following equation:

$$(I.R.F. (FWHM))^2 = (T.T.S.)^2 + (Tw)^2 + (Tj)^2$$

where  $Tw$  is the pulse width of the laser used and  $Tj$  is the time jitter of all equipments used.

⑧T.T.S. stands for Transit Time Spread which is the fluctuation in transit time between individual pulse and specified as an FWHM with the incident light having a single photoelectron state. This value negligible  $Tw$  and  $Tj$ .

# MCP-PMTs R3809U SERIES

Figure 1: Typical spectral response

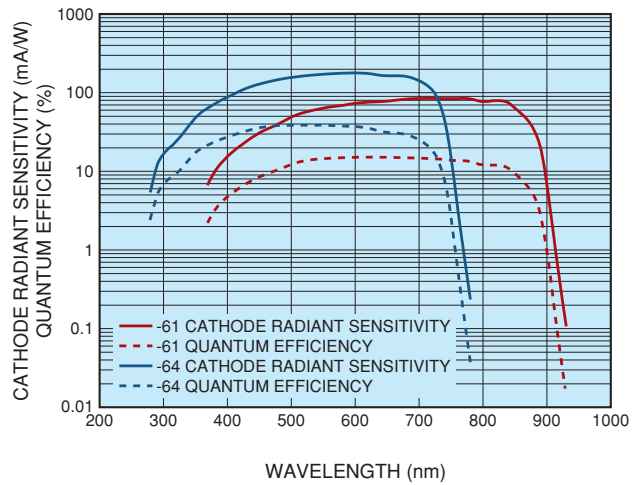
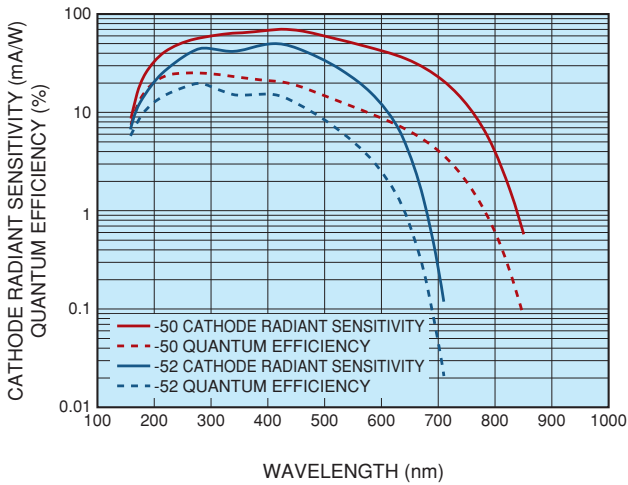

Figure 2: Typical gain

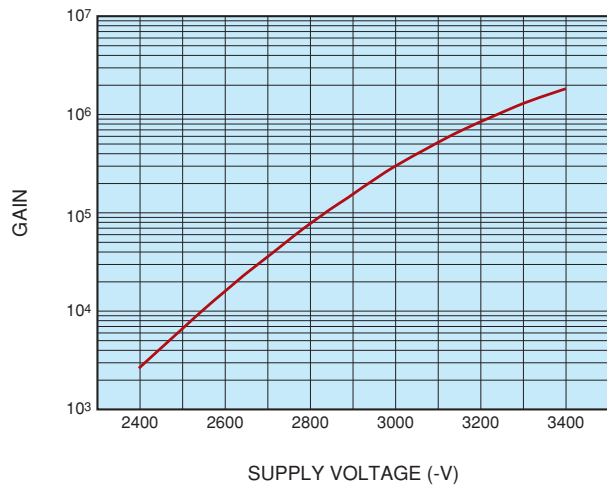

Figure 3: Typical plateau

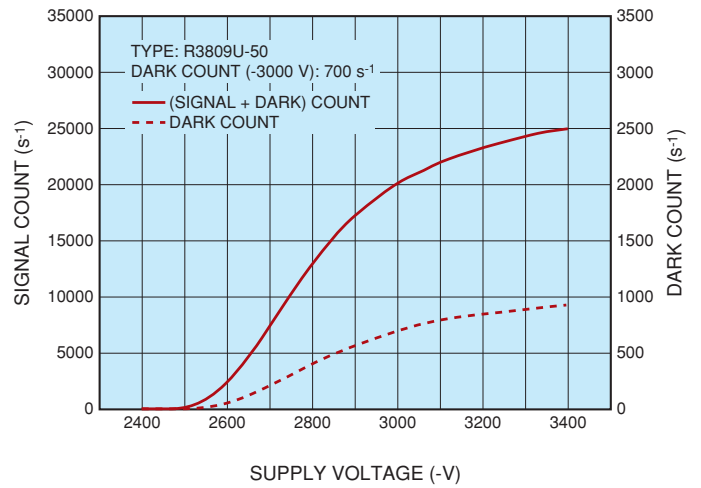

Figure 4: Typical waveform

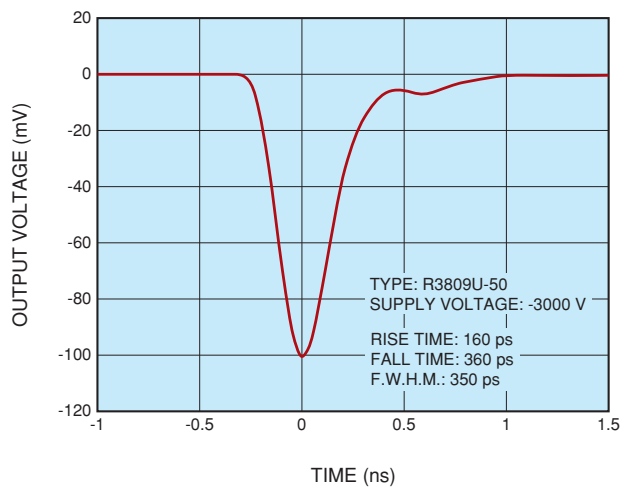

Figure 5: Typical I.R.F.

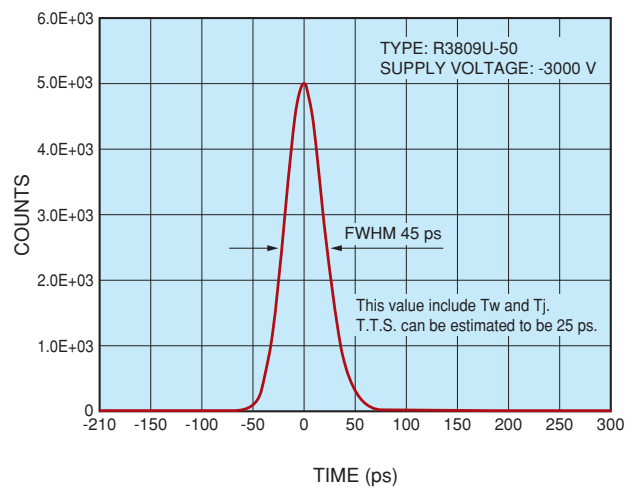
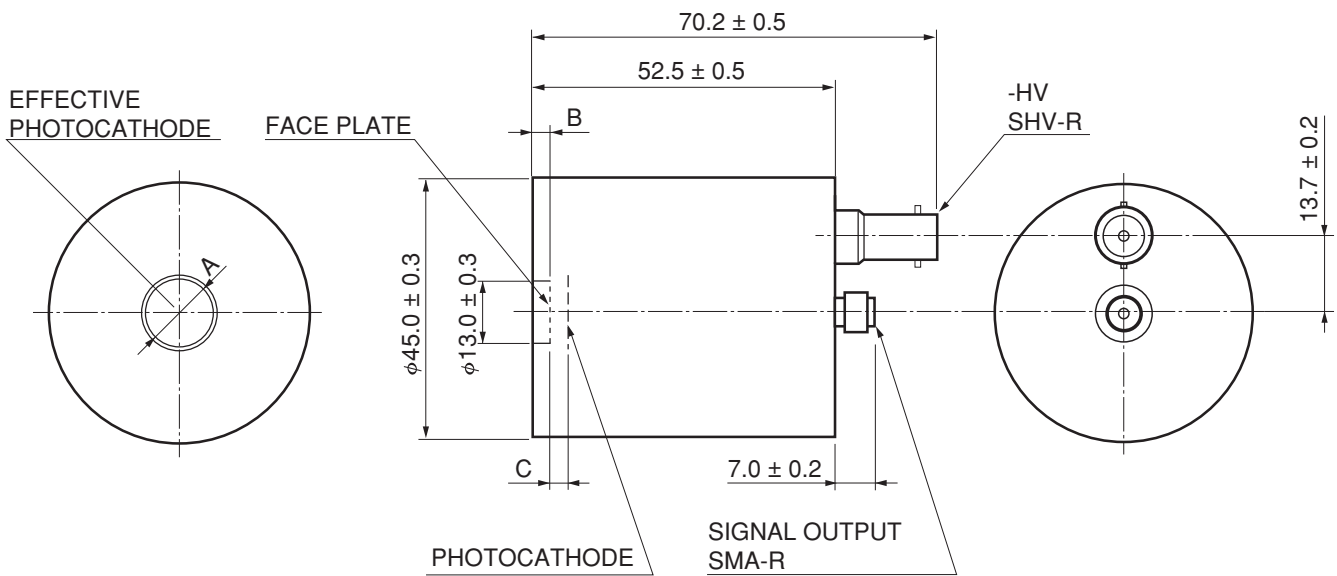
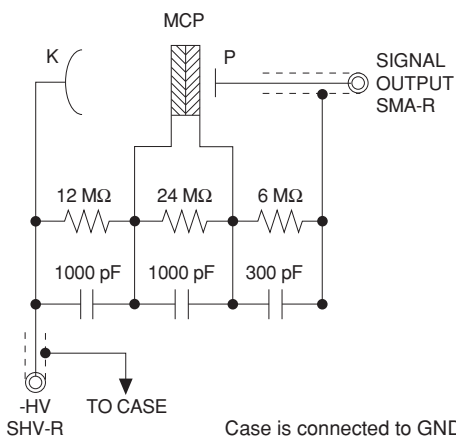

Figure 6: Dimensional outline (Unit: mm)



Suffix	A	B	C
-50 / -52	φ11 Min.	3.0 ± 0.2	3.2 ± 0.1
-61 / -64	φ10 Min.	2.8 ± 0.2	4.2 ± 0.1



Case is connected to GND inside of this product.  
Actual resistor values may slightly differ from the above.

# MCP-PMTs R3809U SERIES

## ACCESSORIES

### Thermoelectric cooling unit C10373 series, Holder E3059-500



Left: Power supply, Right: Cooled PMT housing



Parameter	Description / Value	Unit
Cooling method	Thermoelectric cooling using peltier module	—
Heat exchange medium	Water	—
Cooling temperature <sup>①</sup>	Approx. -30	°C
Cooling time	Approx. 120	min
Applicable PMT holder <sup>②</sup>	E3059-500	—
AC Input voltage	100 to 240	V
Operating ambient temperature <sup>③</sup>	+5 to +40	°C
Operating ambient humidity <sup>③</sup>	Below 75	%
Storage temperature <sup>③</sup>	-15 to +50	°C
Storage humidity <sup>③</sup>	Below 80	%

#### NOTES

- ① Uses cooling water at 20 °C.  
 ② Sold separately. The E3059-500 exclusive holder is necessary for R3809U series.  
 ③ No condensation.

### High speed amplifier C5594 series



Parameter	-12	-22	-44	Unit
Input connector	SMA plug (male)	SMA receptacle (female)	BNC receptacle (female)	—
Output connector	SMA receptacle (female)			—
Frequency response range	50 kHz to 1.5 GHz			—
Voltage gain	Typ.	36		dB
Current-to-voltage conversion factor		3.15		mV/A
Input / Output impedance		50		Ω
Noise figure (NF)	Typ.	5		dB
Supply voltage		+12 to +16		V
Supply current	Max.	95		mA

### Bench-top high voltage power supply C9727 / C9727-01



Parameter	Description / Value	Unit
Output voltage	0 to -3500	V
Maximum output current	2	mA
Line regulation against 10 % line voltage change <sup>①②</sup>	Max. 0.005	%
Load regulation against 0 % to 100 % load change <sup>①</sup>	Max. 0.03	%
Ripple / Noise (p-p) <sup>①②</sup>	Typ. 0.003	%
Drift (after 30 min warm-up) <sup>①②</sup>	Typ. 0.05	%/h
Temperature coefficient <sup>①②</sup>	Typ. 0.01	%/°C
AC input voltage	100 to 240	V
Power consumption <sup>①②</sup>	Max. 60	V·A
Operating ambient temperature <sup>③</sup>	0 to +40	°C
Operating ambient humidity <sup>③</sup>	below 85	%
Storage temperature <sup>③</sup>	-20 to +50	°C
Storage humidity <sup>③</sup>	below 90	%

#### NOTES

- ① At maximum output voltage.  
 ② At maximum output current.  
 ③ No condensation.

## HAMAMATSU PHOTONICS K.K. [www.hamamatsu.com](http://www.hamamatsu.com)

### Electron Tube Division

314-5, Shimokanzo, Iwata City, Shizuoka Pref., 438-0193, Japan, Telephone: (81)539/62-5248, Fax: (81)539/62-2205

U.S.A.: HAMAMATSU CORPORATION: 360 Foothill Road, Bridgewater, NJ 08807, U.S.A., Telephone: (1)908-231-0960, Fax: (1)908-231-1218 E-mail: [usa@hamamatsu.com](mailto:usa@hamamatsu.com)

Germany: HAMAMATSU PHOTONICS DEUTSCHLAND GMBH.: Arzbergerstr. 10, 82211 Herrsching am Ammersee, Germany, Telephone: (49)8152-375-0, Fax: (49)8152-265-8 E-mail: [info@hamamatsu.de](mailto:info@hamamatsu.de)

France: HAMAMATSU PHOTONICS FRANCE S.A.R.L.: 19 Rue du Saule Trappu, Parc du Moulin de Massy, 91882 Massy Cedex, France, Telephone: (33)1 69 53 71 00, Fax: (33)1 69 53 71 10 E-mail: [info@hamamatsu.fr](mailto:info@hamamatsu.fr)

United Kingdom: HAMAMATSU PHOTONICS UK LIMITED: 2 Howard Court, 10 Tewin Road, Welwyn Garden City, Hertfordshire, AL7 1BW, UK, Telephone: (44)1707-294888, Fax: (44)1707-325777 E-mail: [info@hamamatsu.co.uk](mailto:info@hamamatsu.co.uk)

North Europe: HAMAMATSU PHOTONICS NORDEN AB: Torshamnsgatan 35, 16440 Kista, Sweden, Telephone: (46)8-509-031-00, Fax: (46)8-509-031-01 E-mail: [info@hamamatsu.se](mailto:info@hamamatsu.se)

Italy: HAMAMATSU PHOTONICS ITALIA S.R.L.: Strada della Moia, 1 int. 6 20044 Arese (Milano), Italy, Telephone: (39)02-93 58 17 33, Fax: (39)02-93 58 17 41 E-mail: [info@hamamatsu.it](mailto:info@hamamatsu.it)

China: HAMAMATSU PHOTONICS (CHINA) CO., LTD.: 1201, Tower B, Jiamei Center, 27 Dongsanhuan Bellu, Chaoyang District, 100020 Beijing, P.R. China, Telephone: (86)10-6586-6006, Fax: (86)10-6586-2866 E-mail: [hpc@hamamatsu.com.cn](mailto:hpc@hamamatsu.com.cn)

Taiwan: HAMAMATSU PHOTONICS TAIWAN CO., LTD.: 13F-1, No.101, Section 2, Gongdao 5th Road, East Dist., Hsinchu City, 300046, Taiwan(R.O.C) Telephone: (886)3-659-0080, Fax: (886)3-659-0081 E-mail: [info@hamamatsu.com.tw](mailto:info@hamamatsu.com.tw)

TPMH1067E13  
APR. 2024 IP